



SZ2165 Boiler Controller

Description

The SZ2165 is a microprocessor based boiler controller. It is designed for use on multi-stage boiler applications and includes chiller support and control.

Features

- Stand-alone or network operation
- 365-day time clock with two holiday schedules, automatic leap year and daylight saving correction
- No backup battery required for control parameters, schedule or clock
- Hot water supply and return water temperature inputs
- Mixed water temperature input
- Chilled water supply and return temperature input
- Two digital outputs for chillers
- One digital output for alarm
- Outdoor air temperature input
- Outdoor air reset control
- Two digital inputs for pump status
- External time clock input
- Six digital outputs for boilers and boiler pumps
- Adjustable offsets and differentials on digital outputs
- Lead/Lag sequencing (rotation) of up to four boilers
- Two modulating analog outputs for valves and VFD
- LEDs for monitoring status
- Automatic rotation of pumps
- Alarm output
- Selectable normally open or normally closed relay outputs

Contents

Description	1
Features	1
Mounting	1
Wiring	2
Setup	3
Programming	3
Sequence of Operations	8
Checkout & Troubleshooting	8
LED Description	9

Mounting

The SZ2165 is designed for mounting using four #10 sheet metal screws. Prior to mounting, the jumpers should be placed. (See setup instructions.) If the unit will be stand-alone, all programming should be completed before installation. If the unit will be wired for communications, a unique address should be programmed into the unit. (See programming instructions.)

Wiring

The SZ2165 terminal designations are shown below.

REMOTE SENSOR WIRING

The SZ2165 accepts six 1000 Ω two-wire platinum sensors. Consult the TS Series Temperature Sensor submittal datasheet for a complete listing of packaging and application styles. When using TCS Basys Controls three-wire sensors, use the black and red leads, and either clip or twist off the white lead. The wiring length should not exceed 250 feet.

POWERING THE SZ2165

The SZ2165 is powered from 24 VAC +/- 20 %. If wiring for communications, dedicated power must be used to power the SZ2165. Several S-series controllers may be powered from the same transformer, provided that the transformer has enough power.

Caution: Do not connect to 120VAC. When multiple TCS/Basys Controls devices are using a single transformer, the polarity of the power wiring must be maintained because all TCS devices are half-wave rectified and have common return paths.

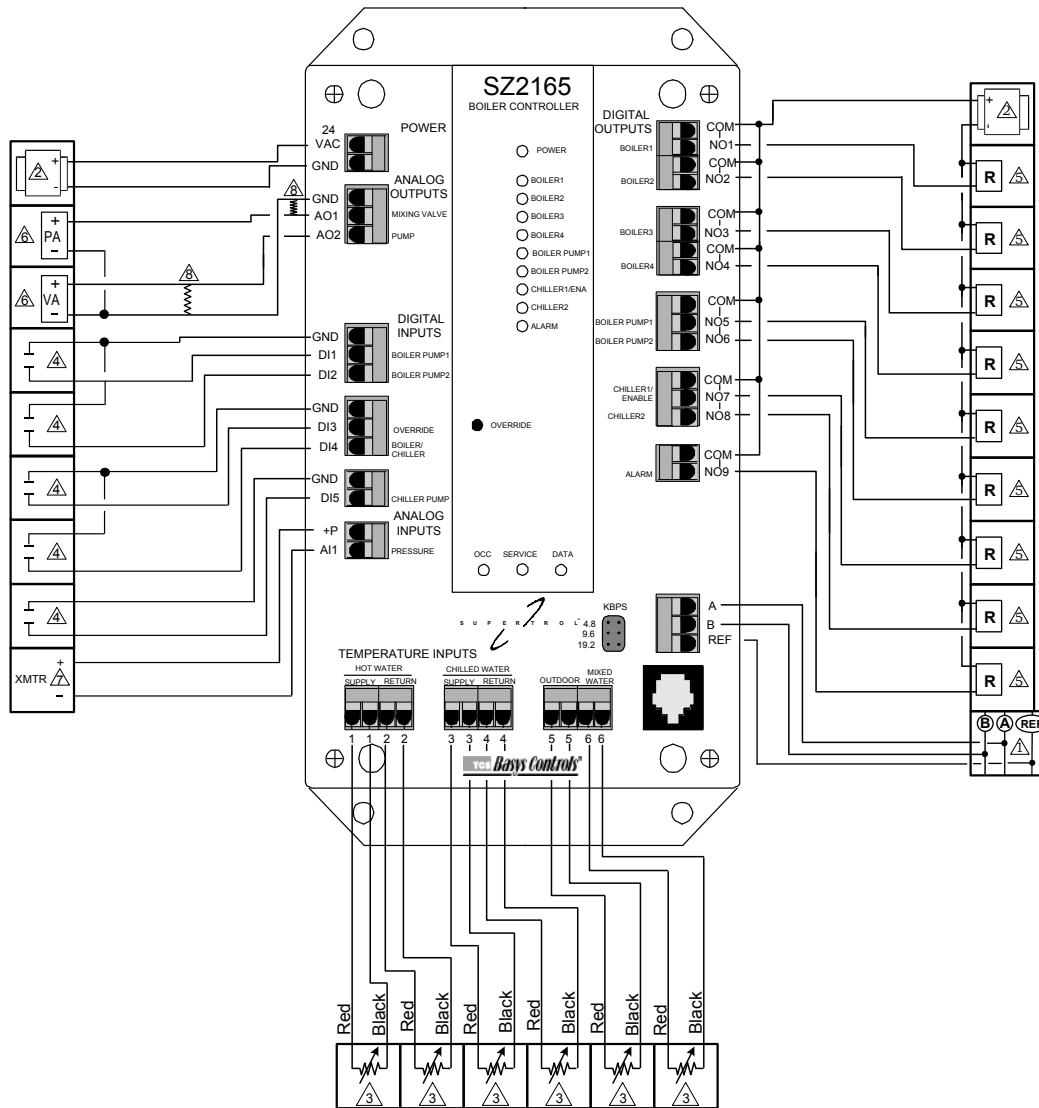

- | | |
|--|--|
| 1 For communication wiring, use twisted, shielded 22 AWG. Must be run separately. | 6 4 to 20 mA output. 600 ohm max. Do not power actuator with power from the controller. The controllers are half-wave rectified, whereby the power ground is common with the signal ground. |
| 2 24 VAC transformer. See powering instructions. | 7 2-wire, 4 to 20 mA transmitter. Sensor input wiring 18 AWG, twisted, shielded pair. |
| 3 Sensor input wiring 18 AWG, twisted, shielded pair. | 8 Add 500 ohm resistor (included in bag) to convert 0/4 to 20mA to, 0/2 to 10 VDC. |
| 4 Dry contact. Must not be powered. | |
| 5 External relay. 24 VAC Coil | |

Setup

BAUD RATE SELECTION

The SZ2165 must be programmed using a PC and TCS Basys Controls software. A communication baud rate must be set by placing one jumper in the area shown. This baud rate must be the same for all devices.

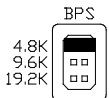
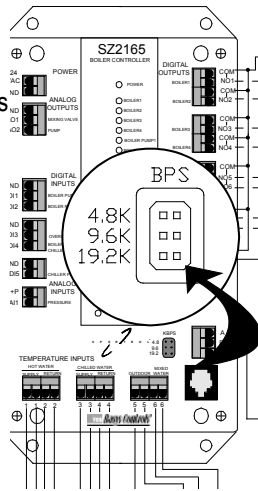

For a 4.8K baud rate.

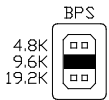

For a 9.6K baud rate.

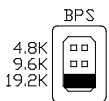

For a 19.2K baud rate.

Programming

The SZ2165 must be programmed with a PC. A jack on the face allows local access for programming. If you plan to program the controller while it is on a network, prior to putting the controller on the network, a unique address must be set in the controller by accessing it through the port on the front.

For more information on programming using a PC and the TCS Insight software, consult your TCS software manuals.

CONTROLLER ADDRESS

The factory default address for an SZ2165 is 165. On the "Network>Poll" tab, right click on the desired controller and select "Change Address" from the menu that appears. Next, select the desired address from the use the drop-down menu and hit ENTER. Finally, click "Yes" in the Change Controller Address window that appears.



INTERNAL TIME CLOCK

On the "Schedules>Date and Time" tab, you can see and modify the controller's time (military time), day of the week, date and year. Click on "Read" if you would like to see the current time, day of week and date in the controller. Click on "To PC Time" read these parameters from your computer instead and automatically program them into the

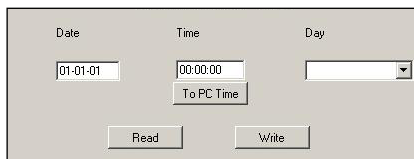

SZ2165. Finally you can click on "Write" to send the updated time, day of week, and date to the controller.

EVENT SCHEDULING

On the "Schedules>Schedules" tab there are two occupied time periods per day, and thus two time schedules (A and B). Let us say that the occupied time for a particular day is from 8:00AM to 12:00PM and from 1:00PM to 5:00PM. In the "A" schedule you could enter 8:00 to 12:00, and in the "B" schedule you could enter 13:00 to 17:00. You can reverse the "A" and "B" schedules also. You can also enter 8:00 to 17:00 for the "A" schedule and 0:00 to 0:00 for the "B" schedule. 0:00 (12:00AM) starts the day, and 24:00 (12:00AM) ends the day. *Note:* occupied times that span midnight have to be coordinated using two days' time schedules.

NOTE: The start of an occupied period is delayed by the power-on delay value.

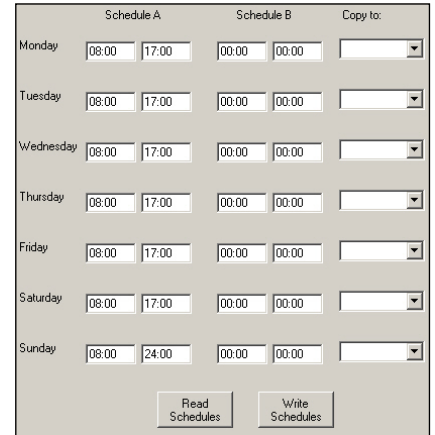

HOLIDAY 1 / HOLIDAY 2

On the "Schedules>Holiday" tabs the holiday schedules set which days in a year will use Holiday 1 & Holiday 2 schedules as defined. Each holiday consists of a month and date, as well as the number of days that the holiday will be in effect.

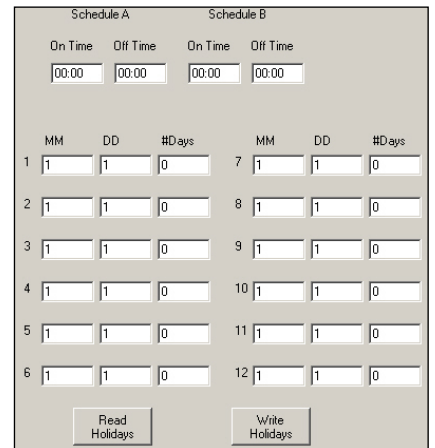

MONITORING

The "Monitoring" tab displays the current temperatures and the status of all inputs and outputs. These values are automatically read when accessing this tab initially and are automatically refreshed periodically while viewing the tab. By right clicking on a particular point, you can view a live graph of that point over time.



DIGITAL INPUTS

Name	Physical Digital Input	Function	Source	Override
DI1	DI1	Monitor	Local	OFF
DI2	DI2	Monitor	Local	OFF
DI3	DI3	Monitor	Local	OFF
DI4	DI4	Monitor	Local	OFF
		<input type="checkbox"/> Enable DHW Override		
DI5	DI5	Monitor	Local	OFF

Read Page Write Page

On the "Programming> Digital Inputs" tab select whether you want DI1, DI2, DI3, DI4 or DI5 to be "Local" or "Remote". Local means that the controller uses its own control program when looking at these inputs. Remote means that the controller will only recognize input changes originating from a PC or other communication device.

DI1 can be used for "Boiler Pump 1 Proving" or just "Monitoring". If Boiler Pump 1 Proving is selected, the controller will turn on the Boiler Pump 1 and then wait 30 seconds to make sure the Pump is on (DI1 is shorted). This can be accomplished with a flow switch, current switch or some other device. Any time Boiler Pump 1 is on but DI1 is not shorted, "Heating" will be shut down. To restart heating, you must short DI1 to GND.

DI2 can be used for Boiler Pump 2 Proving or Monitoring. If Boiler Pump 2 Proving is selected, the controller will turn on Boiler Pump 2 and then wait 30 seconds to make sure the Pump is on (DI2 is closed). This can be accomplished with a flow switch, current switch or some other device. Any time Boiler Pump 2 is on but DI2 is not closed, Heating will be shut down. To restart heating, you must short DI2 to GND.

DI3 can be used for Monitor, External Override or External Time Clock. If External Override is selected, the controller will use its built-in time clock and schedule to determine whether to be occupied or unoccupied, and will also be occupied as long as DI3 is On (closed). If External Time Clock is chosen, the controller will not use its built-in time clock and schedule to determine whether to be occupied or unoccupied. The controller will be occupied as long as DI3 is On (closed) and unoccupied as long as DI3 is Off (Open). **NOTE: the start of an occupied period is delayed by the power-on delay value.**

DI4 is available for monitoring. Select "Boiler/Chiller Alarm" to monitor alarm conditions such as High Temperature, Low Water Level, etc. (Note: no action will be taken by the controller for this alarm. It is only being monitored.) Select "Monitoring" to detect more general conditions.

If monitoring is selected, there is an option to enable Domestic Hot Water (DHW) Override. When Domestic Hot Water Override is enabled and DI4 is applied, the boiler pumps will turn off and the boiler stages will maintain the high limit setpoint regardless of the reset schedule. This override will operate for a 1 hour maximum, after which the boiler pump will turn back on and the unit will function normally.

DI5 can be used for Chiller Pump Proving or Monitoring. If Chiller Pump Proving is selected, the controller will turn on the Chiller Pump and then wait 30 seconds to make sure the Pump is on (DI5 is closed). This can be accomplished with a flow switch, current switch or some other device. Any time the Chiller Pump 1 is on but DI5 is not shorted, Cooling will be shut down. To restart cooling, you must short DI5 to GND.

REMOTE OVERRIDE

Using DI3 you can override the controller (put it in Occupied Mode). First, using the drop-down menu select "External Override" as the function for DI3. Next using the Source drop-down menu select "Remote" (this means the values come via software). Finally, select "ON" from the Override drop-down menu and then click "Write Page". This will bring the controller to occupied mode permanently. **NOTE: You must change the Source back to Local in order for the controller to go back into normal operation.**

BOILER AND PUMP RELAYS

Boiler Pumps				
<input checked="" type="checkbox"/> Enable Boiler Pump Operation	Outdoor Occ Setpoint	39.6 °F	Outdoor Unocc Setpoint	39.4 °F
<input checked="" type="checkbox"/> Enable Automatic Boiler Pump Rotation	Time Between Rotation	60 hours	Lead Boiler Pump	Pump 1
<input checked="" type="checkbox"/> Enable Pump Lube	Boiler and Boiler Pump Relays			Normally Open
<input checked="" type="checkbox"/> Turn on Boiler Pumps when Occupied	Purge Time	2 min		

The Boiler Pump and Boiler Stage Relay Outputs can operate in N.O. (Normally Open) or in N.C. (Normally Closed) mode. The default is N.O., whereby when the pump or stage output is On, the relay closes. **NOTE: if using N.C. mode, you will need to have pilot relays to turn on the pumps and stages, and the LED indication on the SZ2165 will be reversed, i.e. when the pump or stage is On, the LED is Off and when the pump or stage is Off, the LED is On. N.C. mode will have the pumps and stages fail On.**

BOILER PUMPS

Choose whether or not to enable Boiler Pump Operation. If not selected, the boiler pump outputs will not function.

The boiler pumps can be rotated automatically based on their run times. Choose whether to enable the Automatic Boiler Pump Rotation, and if so, enter the time in hours that one pump must run before switching to the other pump.

LEAD BOILER PUMP

Choose whether Boiler Pump 1 or Boiler Pump 2 will be used as the Lead boiler pump. The other one will be treated as the backup pump. This selection can be used to manually alternate the boiler pumps.

ENABLE PUMP LUBE

Choose whether you want to enable the enable pump lube function. The Enable Pump Lube function turns on the pump every Sunday morning at 4:00AM for the allotted purge time that is programmed in for that particular pump.

SERVICE/ALARM STATUS

The Service Status field on the "Monitoring" tab shows various status messages depending on which alarms have been setup - OK, CWS_Hi/Lo (chilled water supply), HWS_Hi/Lo (hot water supply), BLP1 (boiler pump 1 prove), BLP2 (boiler pump 2 prove), DI4 (boiler/chiller alarm), DI5 (chiller pump prove).

SETPOINTS

Enter Occupied and Unoccupied temperature setpoints for Hot Water Supply, Chilled Water Supply, Mixed Water, Hot Water Return and Analog Input (Pressure). Also enter a High and Low Limit for each setpoint, if desired.

RESET

The analog outputs and digital output stages on the SZ2165 can be setup to use a reset function. This is done by placing a check in the appropriate Enable Reset box. When using the reset function, the Hot Water Supply, Chilled Water Supply, Mixed Water, Hot Water Return and/or Analog Input (Pressure) are the Primary temperature inputs and the Outdoor Air Temperature is the Reset input.

You need to enter a primary occupied and unoccupied setpoint in the Setpoints section above. These setpoints will be adjusted up and down based on the outdoor air temperature, the reset setpoint and the reset factor. The analog output(s) and digital output(s) will be controlled using these calculated setpoint(s).

You need to enter a reset setpoint. A comparison between the outdoor air temperature and this setting will be used in determining the calculated setpoint for each respective input.

You need to enter a reset ratio factor. This is the number of units that the respective input setpoint is raised when the outdoor air temperature falls below the reset setpoint by 1 unit, or the number of units that the respective input setpoint is lowered when the outdoor air temperature rises above the reset setpoint by 1 unit.

example - A hot water valve is controlled using an outdoor air reset schedule. If the outdoor air temperature is 0°F, the hot water temperature is controlled at 200°F. If the outdoor air temperature is 60°F, the hot water temperature is controlled at 80°F.

The hot water supply temperature setpoint is set to 140.

$$(200 + 80) / 2 = 140$$

The reset setpoint for the hot water supply temperature is set to 30.

$$(0 + 60) / 2 = 30$$

The reset factor for the hot water supply temperature is set to 2.

$$(200 - 80) / (60 - 0) = 120 / 60 = 2$$

Hot Water	
Occupied Setpoint	160 °F
Unoccupied Setpoint	120.8 °F
Low Limit	98.8 °F
High Limit	196.9 °F
<input checked="" type="checkbox"/> Enable Hot Water Reset	
Reset Setpoint	29.8 °F
Reset Factor	0
Mixed Water	
Occupied Setpoint	140 °F
Unoccupied Setpoint	100.8 °F
Low Limit	78.8 °F
High Limit	176.9 °F
<input checked="" type="checkbox"/> Enable Mixed Water Reset	
Reset Setpoint	29.8 °F
Reset Factor	0
Chilled Water	
Occupied Setpoint	45.5 °F
Unoccupied Setpoint	78.4 °F
Low Limit	41.6 °F
High Limit	98.2 °F
<input checked="" type="checkbox"/> Enable Chilled Water Reset	
Reset Setpoint	29.8 °F
Reset Factor	0
AI	
Occupied Setpoint	0 psi
Unoccupied Setpoint	0 psi
Low Limit	0 psi
High Limit	78.4 psi
<input checked="" type="checkbox"/> Enable AI Reset	
Reset Setpoint	29.8 °F
Reset Factor	0
Hot Water Return	
Occupied Setpoint	120 °F
Unoccupied Setpoint	80.8 °F
Low Limit	80.8 °F
High Limit	177.3 °F
<input type="button" value="Read Page"/> <input type="button" value="Write Page"/>	

OUTPUTS

Boiler Pumps		
<input checked="" type="checkbox"/> Enable Boiler Pump Operation	Outdoor Occ Setpoint	59.6 °F
	Outdoor Unocc Setpoint	28.4 °F

For the Pump Outputs you need to enter an Occupied and Unoccupied Outdoor Air Temperature Setpoint.

Chiller			
<input checked="" type="checkbox"/> Enable Chiller Stage 1 as Pump	Outdoor Occupied Setpoint	50.2 °F	
	Outdoor Unoccupied Setpoint	79.2 °F	
Purge Time	2 min		
Chiller 1			
Offset	0 °F	Differential	1.2 °F
Min On Time	2 min	Min Off Time	2 min
Chiller 2			
Offset	1.2 °F	Differential	1.2 °F
Min On Time	2 min	Min Off Time	2 min

For a Cooling output (Chiller Stage(s)) the relay energizes when the input equals the Chilled Water Setpoint + Offset + Differential and de-energizes when the input falls to the Chilled Water Setpoint + Offset.

<input checked="" type="checkbox"/> Turn on Boiler Pumps when Occupied			Purge Time	2 min	
Boiler Pump 1					
Min On Time	2 min	Min Off Time	2 min		
Boiler Pump 2					
Min On Time	2 min	Min Off Time	2 min		
Boiler 1					
Offset	0 °F	Differential	2.4 °F	Min On Time	2 min
Offset	0 psi	Differential	1.2 psi	Min Off Time	2 min
Boiler 2					
Offset	2.4 °F	Differential	2.4 °F	Min On Time	2 min
Offset	1.2 psi	Differential	1.2 psi	Min Off Time	2 min
Boiler 3					
Offset	4.7 °F	Differential	2.4 °F	Min On Time	2 min
Offset	2.4 psi	Differential	1.2 psi	Min Off Time	2 min
Boiler 4					
Offset	7.1 °F	Differential	2.4 °F	Min On Time	2 min
Offset	3.6 psi	Differential	1.2 psi	Min Off Time	2 min

For a Heating output (Boiler Stages) the relay energizes when the input equals the Hot Water Setpoint - Offset - Differential and de-energizes when the input rises to the Hot Water Setpoint - Offset.

Enter the Offset and Differential values here.

DELAYS

Enter the Minimum ON and Minimum OFF times (in seconds) here for all of the output stages, as well as a Purge Time and Minimum ON and OFF times (in minutes) for the Loop pump. A Purge Time is the amount of time (in minutes) that the pump will continue to run after all of the stages are off.

BOILER CONTROL

The boiler can be controlled by either Hot Water Supply Temperature

AO1					
<input type="checkbox"/> Enable Mixed Water Control					
Control Type	Hot Water				
Control Action	Direct	Output Range	4-20 mA	Unoccupied Action	ModJiang
Proportional Band	1	Proportional Band	3.1 °F	Proportional Band	7.8 psi
Integral Factor	25	Derivative Factor	200	Setpoint Offset	0 °F
Setpoint Offset	0 psi				

or by Gauge Pressure. Choose the signal that the boiler will be controlled from. Note - all outputs (Analog and Digital) will be controlled based on this decision.

MIXED WATER

If using a valve to control mixed water temperature, place a check in the "Enable Mixed Water Control" checkbox. When you do this, AO1 will be used to control the Mixed Water Temperature independent of Hot Water or Chilled Water control.

PROPORTIONAL + INTEGRAL

The Proportional + Integral function implements a way to anticipate the need for heating using the boiler stages. This function works in conjunction with the programmed offsets and differentials. Select whether to enable the Proportional + Integral function. By default, this function is disabled when the "Integral Setting" is zero. When enabled, the integral setting can be from 1 to 255. Larger numbers speed up the response, while smaller numbers slow down the response.

TEMPERATURE INPUT CALIBRATION

The six temperature inputs are factory calibrated. However, depending on the application (long wire runs, etc.), there may need to be a field adjustment done to these readings. The "Adjusted Reading" is the reading that the SZ2165 actually uses for control. The Offset Value is the number of degrees that the actual input temperature has been adjusted. For example: You measure the hot water supply temperature and it reads 71°. The SZ2165 reading is 72° and the Hot Water Supply Temperature already has an offset of -2.0°. All you need to do is change the offset value to -3.0° and you're done. The SZ2165 will now read 71°.

Boiler Supply	Offset Value	-1.99	°F
Boiler Return	Offset Value	-3.99	°F
Chiller Supply	Offset Value	-1.99	°F
Chiller Return	Offset Value	-3.99	°F
Outdoor Air Temp	Offset Value	-0.99	°F
Mixed Supply	Offset Value	1	°F
<input type="checkbox"/> Enable Hot Water Alarms	Alarm High Limit	136.66	°F
	Alarm Low Limit	73.22	°F
<input type="checkbox"/> Enable Chilled Water Alarms	Alarm High Limit	78.43	°F
	Alarm Low Limit	19.61	°F
AI Pressure Range	Custom Range		
	AI Range Low Value:	0	
	AI Range High Value:	102	
Read Page		Write Page	

The Hot Water Supply and Return inputs are scaled 40 to 240°F (4.4 to 115.6°C). The Chilled Water Supply and Return inputs are scaled 0 to 100°F (-17.8 to 37.8°C). The Mixed Water input is scaled 20 to 220°F (-6.7 to 104.4°C). The Outdoor input is scaled -40 to 160°F (-40 to 71.1°C). These ranges are fixed and cannot be changed.

HOT/CHILLED WATER TEMPERATURE ALARMS

Choose whether to enable High and Low Water Temperature Alarms. If enabled, you will need to enter a High and Low Limit for each desired Water Temp Alarm.

AI PRESSURE RANGE

The boiler can be controlled by either Hot Water Supply Temperature or by Gauge Pressure. If controlled by gauge pressure, choose the range of the pressure transducer as being either 0 to 100 psi, 0 to 500 psi, or custom. If custom select 0 to 100 psi and fill in the AI pressure range high limit.

BOILER STAGE ROTATION

<input checked="" type="checkbox"/> Enable Boiler Stage Rotation	Time Between Change	2	weeks	Hour of Day for Change	0	hours
<input type="checkbox"/> Enable Rotate on Runtime	Rotate Frequency Range	5-1000				hours
Number of Boiler Stages	<input type="checkbox"/> Swap Stages 1 and 2 with 3 and 4	P+I for Boiler Stages	0			
Boiler Stage Ordering						
Boiler 1 Relay	Boiler 2 Relay	Boiler 3 Relay	Boiler 4 Relay			

Choose whether to enable Boiler Stage Rotation. Boiler rotation is cyclical, i.e. before rotation, Boiler 1 is the first stage, Boiler 2 is the second stage, Boiler 3 is the third stage and Boiler 4 is the fourth stage. After one rotation, Boiler 2 is the first stage, Boiler 3 is the second stage, Boiler 4 is the third stage and Boiler 1 is the fourth stage. If using Boiler Stage Rotation, select the number of weeks between rotations and select the time of day that you would like the rotation to occur, or enable rotation based on runtime, then enter the time between change (5 hours to 1000 hours).

BOILER STAGES

Select the number of Boiler Stages that will be used in the Boiler Stage Rotation. If using 4 stages, you can select to "Swap" stages 1 & 2 with stages 3 & 4. This is useful if using two boilers with two stages each.

BOILER STAGE ORDERING

Select the boiler stage ordering. The term Boiler refers to the physical connections to the SZ2165. The term Stage refers to the order in which the boiler stages cycle on and off. The factory default is to have Boiler 1 be Stage 1, Boiler 2 be Stage 2, Boiler 3 be Stage 3 and Boiler 4 be Stage 4. Note: the boiler stages can be placed in any order whether using boiler rotation or not. If boiler rotation is used, this is the starting order, after which the boiler stages will be rotated in order.

CHILLER 1 / PUMP ENABLE

Chiller Stage 1 can either be the first of two stages of chiller control, or it can be treated like a pump (or enable) function. If selected as a pump (or enable) function, outdoor air temperature will determine when this output energizes. If selected as chiller stage 1, chilled water temperature will determine when this output energizes.

CHILLER STAGE ROTATION

<input checked="" type="checkbox"/> Enable Chiller Stage Rotation	Time Between Change	2	weeks	Hour of Day for Change	0
Chiller Stage Ordering					
Chiller 1 Relay	Chiller 2 Relay				

If Chiller Stage 1 was not selected to be a pump in the above step, choose whether to enable Chiller Stage Rotation. If using Chiller Stage Rotation, select the number of weeks between rotations and select the time of day which you would like the rotation to occur. Note: the chiller stages can be placed in any order whether using chiller rotation or not. Chiller Stage 1 must not be enabled as a Pump. If chiller rotation is used, this is the starting order, after which the chiller stages will be alternated.

CHILLER STAGE ORDERING

Select the chiller stage ordering. The term Chiller refers to the physical connections to the SZ2165. The term Stage refers to the order in which the chiller stages cycle on and off. The factory default is to have Chiller 1 be Stage 1 and Chiller 2 be Stage 2.

ANALOG OUTPUT 1

AO1					
<input type="checkbox"/> Enable Mixed Water Control	Control Type	Hot Water	Unoccupied Action	Modulating	
Control Action	Direct	Output Range	4-20 mA	Proportional Band	3.1
Proportional Band	1	Proportional Band	1	Proportional Band	7.8
Integral Factor	25	Derivative Factor	200	Setpoint Offset	0
Setpoint Offset	0	Setpoint Offset	0	Setpoint Offset	0

Analog output one on the SZ2165 can be used to control Hot Water Supply Temperature, Mixed Water Temperature or control based on Pressure.

During the occupied time, an analog output modulates to maintain a heating or cooling temperature setpoint. During the unoccupied time you will need to choose whether the analog output will modulate, remain at 20mA, or remain at (0 or 4)mA.

A proportional band (throttling range), whether you want the analog output to modulate from 4 to 20mA or 0 to 20mA, and direct or reverse action must also be programmed.

For control without "Integral" and "Derivative", enter 0 for both. The proportional band is 0 to 100%, while the integral and derivative values are numbers from 0 to 255. The default PID values for AO1 are

P=4, I=25, D=200, PID Step=5, PID delay=2 and PID Error DB=0. See the PID Control Factors section for more details.

ANALOG OUTPUT 2

Analog output two can be used to control a Heating Device (based on Hot Water Supply Temperature), a Cooling Device (based on Chilled Water Supply Temperature) or control based on Hot Water return Temperature.

During the occupied time, an analog output modulates to maintain a heating or cooling temperature setpoint. During the unoccupied time you will need to choose whether the analog output will modulate, remain at 20mA, or remain at (0 or 4)mA.

A proportional band (throttling range), whether you want the analog output to modulate from 4 to 20mA or 0 to 20mA, and direct or reverse action must also be programmed.

For control without "Integral" and "Derivative", enter 0 for both. The proportional band is 0 to 100%, while the integral and derivative values are numbers from 0 to 255. The default PID values for AO2 are P=4, I=25, D=200, PID Step=5, PID delay=2 and PID Error DB=0. See the PID Control Factors section for more details.

PID CONTROL FACTORS

There are three main factors involved in PID control - the proportional, the integral and the derivative factors. The proportional factor dictates how much gain the input signal error should be given with respect to the derivative and the integral error terms. A large integral factor will cause the output to respond quickly to changes on the input however the output could oscillate and overshoot the setpoint. A large derivative factor will cause the output response to be sluggish and slow to change and the output will settle above the desired set point. The derivative term is divided by the PID delay. The default values programmed at the factory are a good point; however, those values should be adjusted/tuned as needed for your particular installation to achieve the desired operation.

PID OPTIONS

The default values are Step Constant=1, PID delay=10 and PID Error DB=0. The Step Constant determines how large of step the output takes - the larger the number, the smaller the step size. The Step Constant is typically 1, but should NEVER be 0 (doing so will cause the system to stay at full output). The Delay parameter specifies how quickly the output should evaluate error between the current output and the desired output. The PID delay can be used to offset a slow moving motor allowing the motor to catch up to its input signal before the error term is reevaluated. The Error Deadband allows the system to overlook error between the desired setpoint and the input signal to help the system stabilize. The Error Deadband is typically 0. It is predominantly used in a situation where a small amount of error would cause a large swing in the output or response (for example, CFM output versus supply or input pressure).

DELAY ON POWER

After recovering from a power loss, the controller will wait this amount of time before starting to control. Different controllers in one building can have different delays so that all units don't come on at the same time. Enter a delay time (in seconds) that you want the Controller to use on power up.

DAYLIGHT SAVING TIME

Daylight Saving Time (DST) in the U.S. is currently from the 2nd Sunday of March to the 1st Sunday of November. Products shipped starting in 2007 with firmware version 1.5 or higher accommodate the new DST schedule. Products shipped starting in 2008 with firmware version 2.0 or higher accommodate the new DST schedule and have the ability to be programmed to accommodate any future schedules that may be used. Should the schedule change and you need to customer program the DST start and end dates, simply enable the "Daylight Saving Time" option within the software and enter the starting month + week and the ending month + week.

COMMUNICATION FAILURE

If "Enable Comm. Loss Function" is selected, the SZ2165 will go into occupied control mode if communications with it is lost and it will stay in the mode until communications returns. The "Delay Before Loss of Comm Function" value is the number of seconds the unit will wait after communications are lost before engaging the Comm. Loss Function. Be sure to set the Comm. Delay time to at least 60 seconds as the QD2040 and QD2010 poll the local controller network once per minute.

HOLIDAY VANISHING

Choose whether to enable the Holiday Vanishing Feature. If checked, the SZ2165 will make the number of days for a holiday 0 after the holiday is over. This will keep the holiday from occurring in subsequent years if it is not reprogrammed.

OVERRIDE STATUS

The "Time Allowed" field is the number of minutes from 0 to 255 (4 hr., 15 min.) which the controller will hold an unoccupied system occupied, when its override button is pressed. You can also enable "Occupied Override" which allows the override to work during occupied periods. In that case, the controller would go from occupied to unoccupied when its override button is pressed.

REMOTE OVERRIDE

In order to override the controller (put it to Occupied Mode), select "ON" from the drop-down and then click on WRITE PAGE. This will bring the controller to occupied mode for the amount of time set on the previous screen in the "Time Allowed" box. If the override time needs to be extended, make sure that "On" is selected and then click WRITE PAGE. This will restart the override timer. To stop the override, select "OFF" from the drop-down and then click on WRITE PAGE.

Sequence of Operation

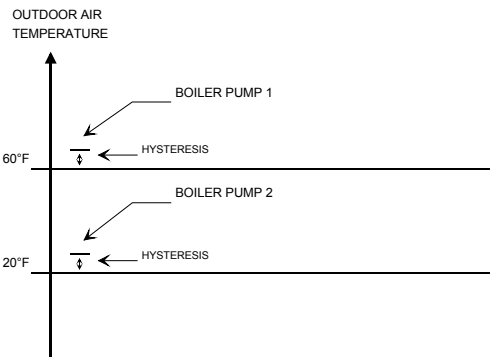
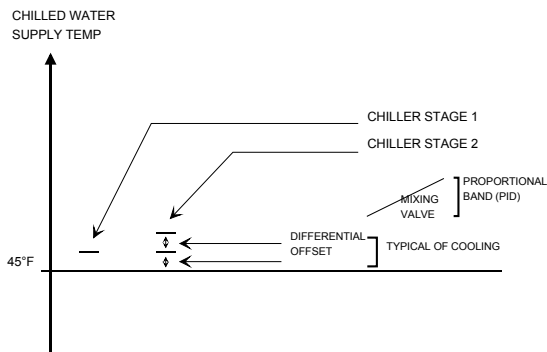
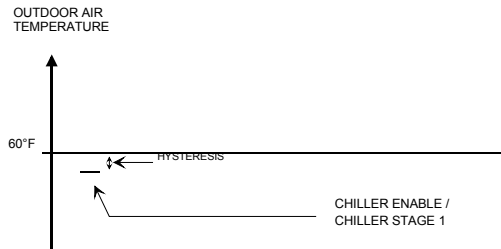
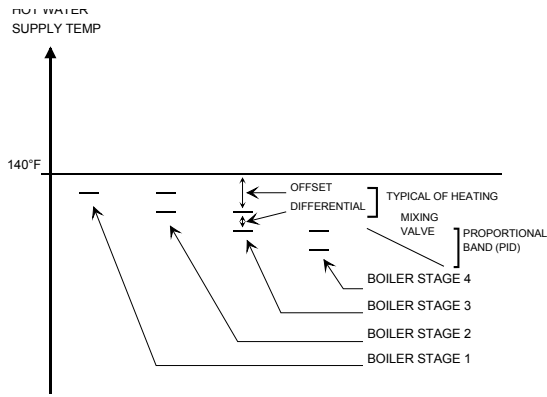

Checkout & Troubleshooting

CHECKOUT

1. Be sure to check and verify all wiring before powering the SZ2165.
2. Turn power on. The SZ2165 "Power" LED should light up. Then the Service LED will blink for 15 seconds while the electronics stabilize.
3. If the SZ2165 has not been pre-programmed, It should be programmed at this time.

4. Increase and decrease the Heat and Cool setpoints. This must be done from a PC. Observe the operation of the relay stages and or analog output(s).
5. Note that the operation of the SZ2165 will depend on how it is programmed.

The SZ2165 is now ready for operation.

TROUBLESHOOTING

Power LED will not come on

Check for 24 VAC on terminals "24 VAC" and "GND". The rest of the trouble shooting must be done with a PC and the Revelation Professional software.

No communications

Make sure baud rate selection jumper for the QD1010 and the SZ2165 are the same, and that Revelation is configured for that same baud rate. Address 248 will always work provided that the SZ2165 is NOT connected to a network.

Inputs do not read correctly

The SZ2165 is calibrated at the factory. For the loop supply temperature and other temperature readings make slight adjustments (+/- 12% of the input span). on "Screen D" of the SZ2165 programming screens. (See Temperature Input Calibration on page 6.)

Output operation is not correct

Check programmed parameters, in particular "Reverse" and "Direct" acting selections and "Heat" or "Cool" selections for the analog outputs, and "Offset" and "Differential" selections and "Delay Times" for the relay outputs. Check wiring.

A pump won't turn on

If a pump will not turn on when it should, DI1, DI2 or DI5 may be set for a pump proving function. If a pump fails, DI1, DI2 or DI5 must be momentarily shorted in order to restart the respective pump.

LED Description

Sixteen LEDs on the unit allow the occupant to view the current operating status of the SZ2165.

POWER: This LED will be lit whenever the unit has power.

DIGITAL OUTPUTS: These LEDs will be lit when the corresponding relay outputs are on. Relay outputs include pumps, boiler stages, chiller stages, etc.

OCC: This LED will be on whenever the unit is operating in the occupied mode.

SERVICE: This LED will be on whenever the unit has a service condition. This LED also blinks on powerup until the electronics stabilize.

DATA: This LED will blink when the unit is being accessed by a PC.